



본사 및 공장

인천광역시 남동구 고잔동 725-13번지
남동공단 152블럭 12롯데
TEL:(032)822-6600(대) FAX:(032)821-6604
<http://www.unilok.com>

Head Office and Factory

152 Block-12 Lot, Namdong Industrial Complex,
725-13, Gojan-Dong, Namdong-Gu, Incheon, KOREA.
TEL:+82-32-822-6600 FAX:+82-32-821-6604
<http://www.unilok.com>

제2공장

인천광역시 남동구 고잔동 684-7번지
남동공단 114블럭 8롯데
TEL:(032)433-6601 FAX:(032)441-7600

Secondary Factory

114 Block-8 Lot, Namdong Industrial Complex,
684-7, Gojan-Dong, Namdong-Gu, Incheon, KOREA.
TEL:+82-32-433-6601 FAX:+82-32-441-7600

Cylinder Connectors



Uni-Lok® Cylinder Connectors are designed and manufactured for the connection of high purity gases in process applications.

Features

VCR/VAR is the standard material for all glands which is UHP(Ultra High Purity) grade 316LSS material with low Sulfur and Manganese for higher weldability

Patented design with bearing for easy installation

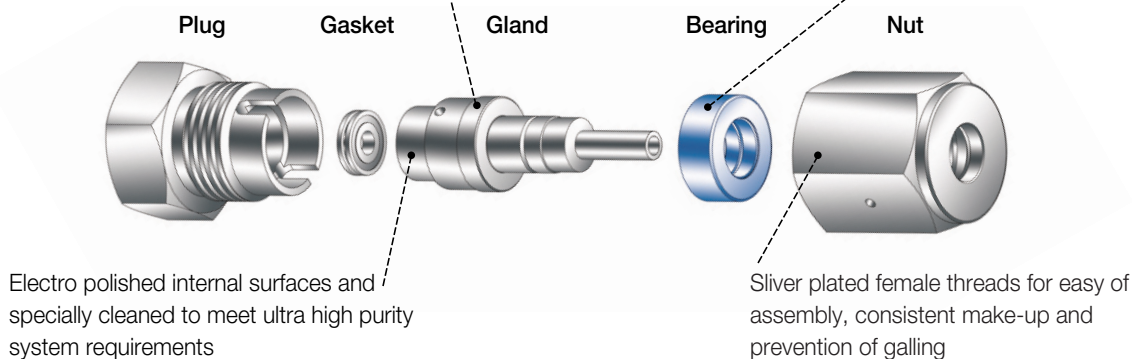

Helium Leak Test

Uni-Lok fittings are rated to a helium leak rate of less than 1×10^{-9} mbar.l./sec and tested in accordance with SEMA-90120391B-STD and SEMI F1-96.

Assembling

According to SEMI E49.6.

Particle Contribution Test

According to ASTM F1394-92.

Packaging

According to ASTM F1394-92.

Moisture Contribution Test

According to SEMA-90120397B-STD.

Moisture Contribution Test

Each component is double bagged to ensure component cleanliness and to protect it from environmental contamination. Referenced specification : SEMI E49.1.

Cleaning

All components are precisely cleaned with 18MB \ddot{Y} deionized water after the passivation procedure. Reference specification : SEMI E49.6.

Part List - CGA Series

Part No.	CGA No.	Parts				
		Nut	Bearing	Gland	Gasket	Plug
USC-C296	296	UM0803R	X	UGL08S	X	UPG296
USC-C320	320	UF0830R	UBR01	UGL01S	UGT01A	UPG320
USC-C326	326	UF0830R	UBR01	UGL04S	X	UPG326
USC-C330	330	UF0830L	UBR01	UGL01S	UGT01A	UPG330
USC-C350	350	UF0830L	UBR01	UGL05S	X	UPG350
USC-C510	510	UM0880L	X	UGL06S	X	UPG510
USC-C540	540	UF0908R	UBR02	UGL09S	X	UPG540
USC-C580	580	UM0960R	X	UGL06S	X	UPG580
USC-C590	590	UM0960L	X	UGL06S	X	UPG590
USC-C660	660	UF1035R	UBR02	UGL03S	UGT03A	UPG660
USC-C670	670	UF1035L	UBR02	UGL03S	UGT03A	UPG670
USC-C678	678	UF1035L	UBR02	UGL07S	UGT01B	UPG678
USC-C679	679	UF1035L	UBR02	UGL10S	UGT05B	UPG679

Part List - JIS

Part No.	CGA No.	Parts				
		Nut	Bearing	Gland	Gasket	Plug
USC-J21-14L	21-14-L	UFJS21L	UBR01	UGL11S	UGT02A	UPG21L
USC-J21-14R	21-14-R	UFJS21R	UBR01	UGL11S	UGT02A	UPG21R
USC-J22-14L	22-14-L	UFJS22L	UBR01	UGL02S	UGT02A	UPG22L
USC-J22-14R	22-14-R	UFJS22R	UBR01	UGL02S	UGT02A	UPG22R
USC-J23-14R	23-14-R	UFJS23R	UBR01	UGL02S	UGT02A	UPG23R
USC-J26-14L	26-14-L	UFJS26L	UBR02	UGL03S	UGT03A	UPG26L
USC-J26-14R	26-14-R	UFJS26R	UBR02	UGL03S	UGT03A	UPG26R

Typical Assembly

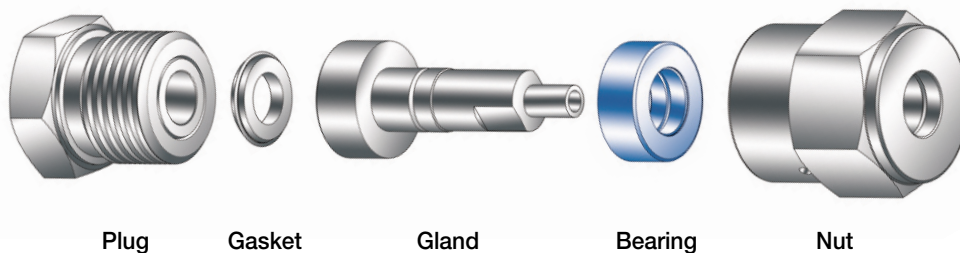

Dimensions are for reference only and are subject to change without prior notice.

Assembly - CGA Series

Type A

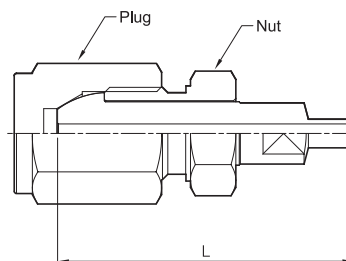
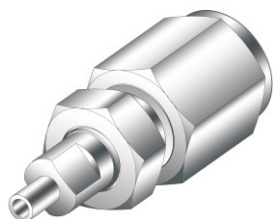

Type B

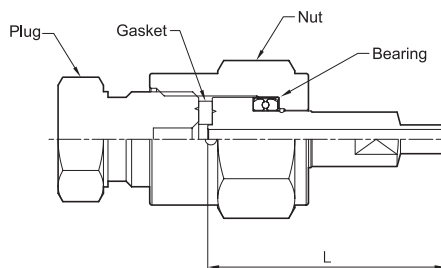
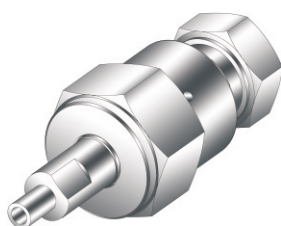

Type C

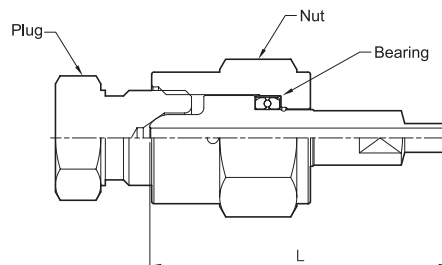
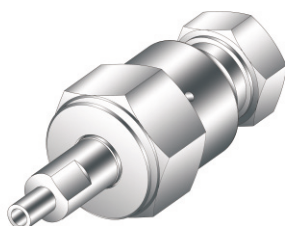

CGA No.	Type	Overall Length(L)		Nut		Plug	Gasket
		inch	mm	Thread	Hex Flat	Thread	Material
296	A	2.57	65.3	0.803-14UNS-2A-RH-EXT	23.81	0.803-14UNS-2B-RH-INT	X
320	B	2.07	52.5	0.830-14NGO-RH-INT	30.16	0.825-14NGO-RH-EXT	PCTFE/R
326	C	2.61	66.2	0.830-14NGO-RH-INT	30.16	0.825-14NGO-RH-EXT	X
330	B	2.07	52.5	0.830-14NGO-LH-INT	30.16	0.825-14NGO-LH-EXT	PCTFE/R
350	C	2.63	66.8	0.830-14NGO-LH-INT	30.16	0.825-14NGO-LH-EXT	X
510	A	2.57	65.3	0.880-14NGO-LH-EXT	23.81	0.885-14NGO-LH-INT	X
540	C	2.63	66.7	0.908-14NGO-RH-INT	30.16	0.903-14NGO-RH-EXT	X
580	A	2.57	65.3	0.960-14NGO-RH-EXT	26.98	0.965-14NGO-RH-INT	X
590	A	2.57	65.3	0.960-14NGO-LH-EXT	26.98	0.965-14NGO-LH-INT	X
660	B	2.28	58.0	1.035-14NGO-RH-INT	31.75	1.030-14NGO-RH-EXT	PCTFE/R
670	B	2.28	58.0	1.035-14NGO-LH-INT	31.75	1.030-14NGO-LH-EXT	PCTFE/R
678	B	2.6	66.0	1.035-14NGO-LH-INT	31.75	1.030-14NGO-LH-EXT	PCTFE
679	B	2.63	66.7	1.035-14NGO-LH-INT	31.75	1.030-14NGO-LH-EXT	PCTFE

Dimensions are for reference only and are subject to change without prior notice.

Assembly - JIS Series

Type B

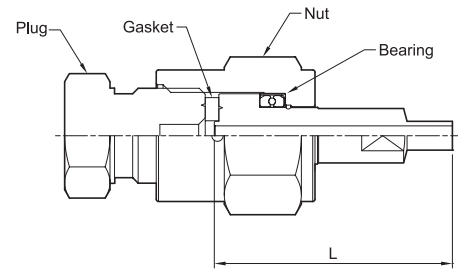

JIS No.	Type	Overall Length(L)		Nut		Plug	Gasket
		inch	mm	Thread	Hex Flat	Thread	Material
21-14-L	B	2.19	55.5	JIS21-14-0L	30.16	JIS21-14-0L	PCTFE/R
21-14-R	B	2.19	55.5	JIS21-14-0R	30.16	JIS21-14-0R	PCTFE/R
22-14-L	B	2.07	55.5	JIS22-14-0L	30.16	JIS22-14-0L	PCTFE/R
22-14-R	B	2.07	55.5	JIS22-14-0R	30.16	JIS22-14-0R	PCTFE/R
23-14-R	B	2.07	55.5	JIS23-14-0R	30.16	JIS23-14-0R	PCTFE/R
26-14-L	B	2.07	58.5	JIS26-14-0L	31.75	JIS26-14-0L	PCTFE/R
26-14-R	B	2.07	58.5	JIS26-14-0R	31.75	JIS26-14-0R	PCTFE/R

Parts - CGA & JIS Series

Bearing

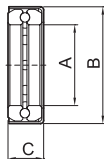

Part No.	A	B	C
UBR01	12.8	18.5	5.7
UBR02	12.8	23.5	9.0

Gasket with 316SS Ring

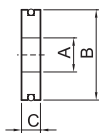

Part No.	A	B	C
UGT01A	6.6	16.8	3.0
UGT02A	10.3	17.3	
UGT03A	9.7	21.5	

Gasket

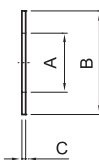

Part No.	A	B	C
UGT01B	7.5	15.4	1.6
UGT05B	8.0	13.5	

Dimensions are for reference only and are subject to change without prior notice.

Parts - CGA & JIS Series

Gland-A

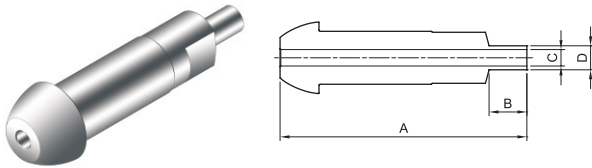

Part No.	A	B	C	D
UGL06S	65.3	10.0	4.35	6.35
UGL08S	65.3			

Gland-B

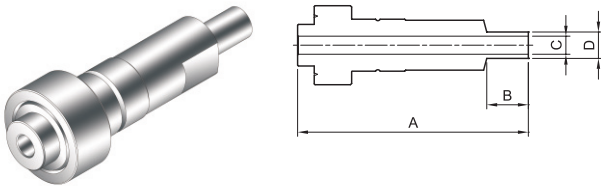

Part No.	A	B	C	D
UGL01S	52.5	10.0	4.35	6.35
UGL02S	55.5			
UGL03S	58.0			
UGL07S	66.1			
UGL10S	66.7			
UGL11S	55.5			

Gland-C

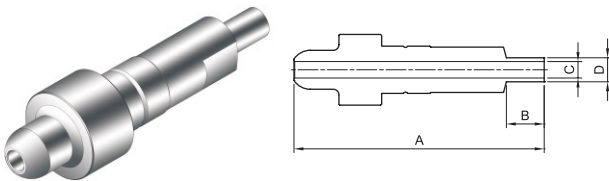

Part No.	A	B	C	D
UGL04S	66.2	10.0	4.35	6.35
UGL05S	66.8			
UGL09S	66.7			

Female Nut

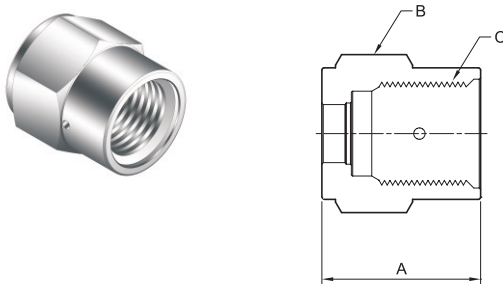

Part No.	A	Hex B	C		
UF-0830L	35.00	30.16	0.830-14NGO-LH-INT		
UF-0830L			0.830-14NGO-LH-INT		
UF-0830R			0.830-14NGO-RH-INT		
UF-0830R			0.830-14NGO-RH-INT		
UF-0908R	36.00	30.16	0.908-14NGO-RH-INT		
UF-1035L			31.75	1.035-14NGO-LH-INT	
UF-1035L				1.035-14NGO-LH-INT	
UF-1035L				1.035-14NGO-LH-INT	
UF-1035R				1.035-14NGO-RH-INT	
UF-JS21L			30.16	30.16	JIS21-14-0L
UF-JS21R					JIS21-14-0R
UF-JS22L					JIS22-14-0L
UF-JS22R	JIS22-14-0R				
UF-JS23R	JIS23-14-0R				
UF-JS26L	31.75	30.16			JIS26-14-0L
UF-JS26R			JIS26-14-0R		

Dimensions are for reference only and are subject to change without prior notice.

Male Nut

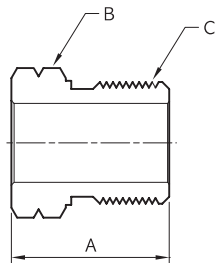
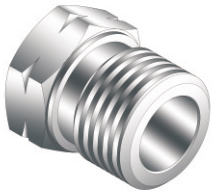

Part No.	A	Hex B	C
UM-0803R	29.00	23.81	0.803-14UNS-2A-RH-EXT
UM-0880L	29.00	23.81	0.880-14NGO-LH-EXT
UM-0960L	29.00	26.98	0.960-14NGO-LH-EXT
UM-0960R	29.00	26.98	0.960-14NGO-RH-EXT

Female Plug

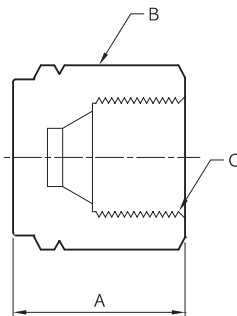

Part No.	A	Hex B	C
UPG296	32.50	26.98	0.803-14UNS-2B-RH-INT
UPG510		30.16	0.885-14NGO-LH-INT
UPG580		31.75	0.965-14NGO-RH-INT
UPG590			0.965-14NGO-LH-INT

Male Plug

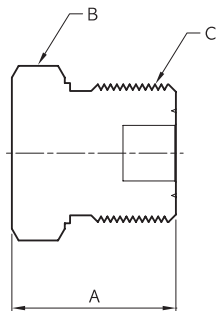

Part No.	A	Hex B	C
UPG320	31.0	23.81	0.825-14NGO-RH-EXT
UPG326	30.0	23.81	0.825-14NGO-RH-EXT
UPG330	31.0	23.81	0.825-14NGO-LH-EXT
UPG350	30.0	23.81	0.825-14NGO-LH-EXT
UPG540	30.0	26.98	0.903-14NGO-RH-EXT
UPG660	26.0	28.57	1.030-14NGO-RH-EXT
UPG670	26.0	28.57	1.030-14NGO-LH-EXT
UPG678	26.0	28.57	1.030-14NGO-LH-EXT
UPG679	26.0	28.57	1.030-14NGO-LH-EXT
UPG21R	31.0	23.81	JIS21-14-OR
UPG21L	31.0	23.81	JIS21-14-OL
UPG22R	31.0	23.81	JIS22-14-OR
UPG22L	31.0	23.81	JIS22-14-OL
UPG23R	31.0	25.40	JIS23-14-OR
UPG26R	31.0	28.57	JIS26-14-OR
UPG26L	31.0	28.57	JIS26-14-OL

Dimensions are for reference only and are subject to change without prior notice.

Parts - CGA & JIS Series

Part No.	DISS No.	Parts					
		Nut	Bearing	Gland	Gasket		Plug
					Nickel	PCTFE	
USC-D632	632	UF-1035R	UBR-02	UGL-632	DISS-UNGT	DISS-UGT	UPG-632
USC-D634	634	UF-1035R	UBR-02	UGL-634	DISS-UNGT	DISS-UGT	UPG-634
USC-D636	636	UF-1035R	UBR-02	UGL-636	DISS-UNGT	DISS-UGT	UPG-636
USC-D638	638	UF-1035R	UBR-02	UGL-638	DISS-UNGT	DISS-UGT	UPG-638
USC-D640	640	UF-1035R	UBR-02	UGL-640	DISS-UNGT	DISS-UGT	UPG-640
USC-D642	642	UF-1035R	UBR-02	UGL-642	DISS-UNGT	DISS-UGT	UPG-642
USC-D712	712	UF-1130R	UBR-02	UGL-712	DISS-UNGT	DISS-UGT	UPG-712
USC-D714	714	UF-1130R	UBR-02	UGL-714	DISS-UNGT	DISS-UGT	UPG-714
USC-D716	716	UF-1130R	UBR-02	UGL-716	DISS-UNGT	DISS-UGT	UPG-716
USC-D718	718	UF-1130R	UBR-02	UGL-718	DISS-UNGT	DISS-UGT	UPG-718
USC-D720	720	UF-1130R	UBR-02	UGL-720	DISS-UNGT	DISS-UGT	UPG-720
USC-D722	722	UF-1130R	UBR-02	UGL-722	DISS-UNGT	DISS-UGT	UPG-722
USC-D724	724	UF-1130R	UBR-02	UGL-724	DISS-UNGT	DISS-UGT	UPG-724
USC-D726	726	UF-1130R	UBR-02	UGL-726	DISS-UNGT	DISS-UGT	UPG-726
USC-D728	728	UF-1130R	UBR-02	UGL-728	DISS-UNGT	DISS-UGT	UPG-728

Typical Assembly

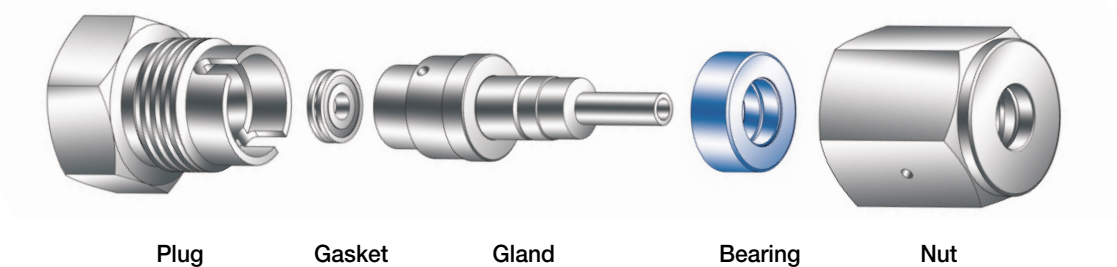

Dimensions are for reference only and are subject to change without prior notice.

Assembly - DISS

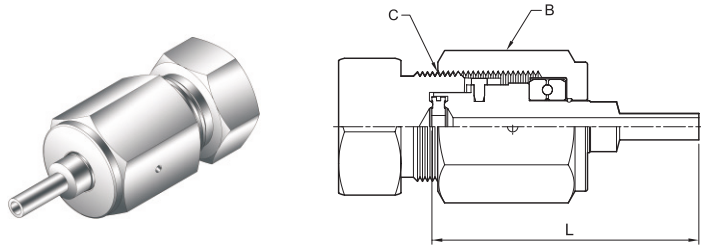

DISS No.	Overall Length L		Hex Flat B		Thread C
	inch	mm	inch	mm	
632	2.51	63.80	1-1/4	31.75	1,035-14NGO-RH-INT
634					
636					
638					
640					
642					
712					
714					
716					
718					
720	1-3/8	34.93			1,125-14NGO-RH-INT
722					
724					
726					
728					
728					

Parts - DISS Series

Bearing

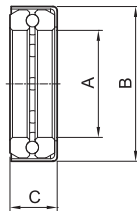

Part No.	A	B	C
UBR02	12,8	23,5	9,00

Gasket

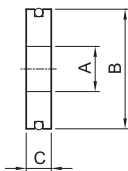

Part No.	A	B	C	Material
DISS-UGT	5,4	14,3	3,0	PCTFE
DISS-UNGT	5,4	14,3	3,2	Nickel

Dimensions are for reference only and are subject to change without prior notice.

Gland

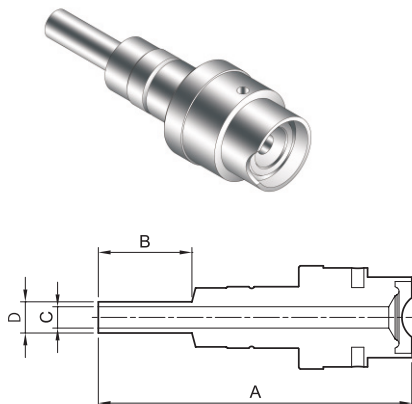

Part No.	A	B	C	D
UGL- 632	63.8	19.05	4.35	6.35
UGL- 634				
UGL- 636				
UGL- 638				
UGL- 640				
UGL- 642				
UGL- 712				
UGL- 714				
UGL- 716				
UGL- 718				
UGL- 720				
UGL- 722				
UGL- 724				
UGL- 726				
UGL- 728				

Nut

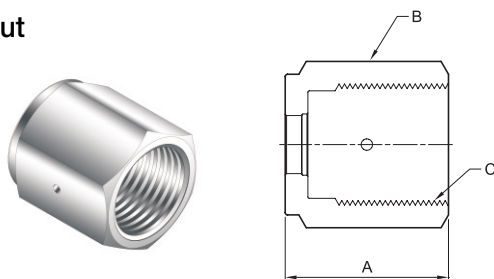

Part No.	A	Hex B	C
UF-1035R	36.0	31.75	1,035-14NGO-RH-INT
UF-1130R		34.93	1,125-14NGO-RH-INT

Plug

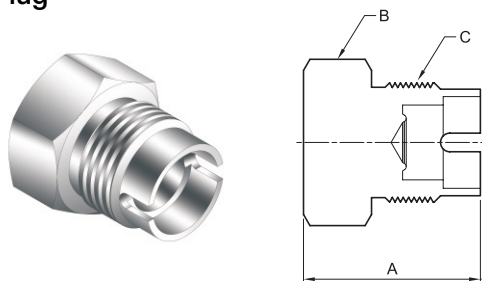

Part No.	A	Hex B	C
UPG- 632	39.0	31.75	1,035-14NGO-RH-EXT
UPG- 634			
UPG- 636			
UPG- 638			
UPG- 640			
UPG- 642			
UPG- 712			1,125-14NGO-RH-EXT
UPG- 714			
UPG- 716			
UPG- 718			
UPG- 720			
UPG- 722			
UPG- 724			
UPG- 726			
UPG- 728			

Dimensions are for reference only and are subject to change without prior notice.